

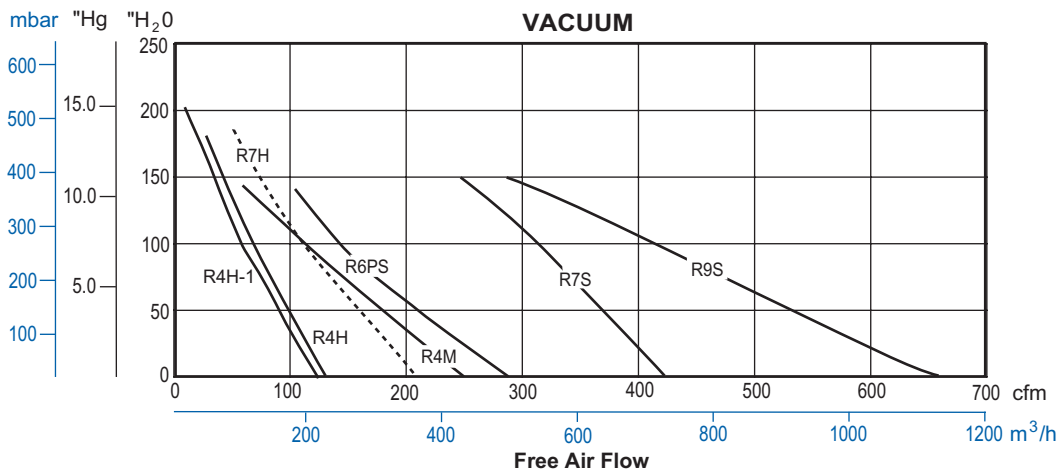

Performance Curves - High Range for Pressure/Vacuum

Motor mounted series R4H, R4H-1, R4M, R6PS, R7H, R7S, R9S

Performance at 60 Hz

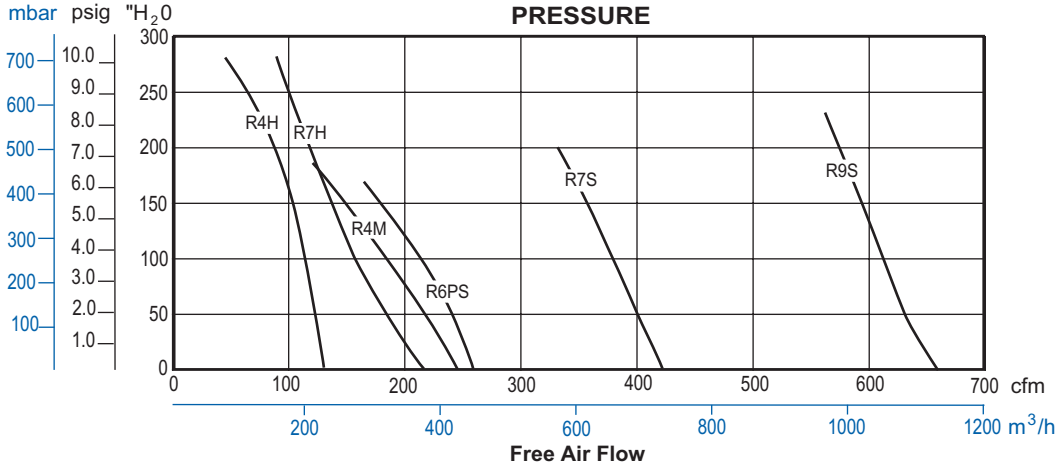

Gast advertises blower performance in Free Air Flow, or air subjected to only atmospheric pressure. (See above curves)

Some blower manufacturers advertise vacuum performance in CFM Inlet Air - measurement of the suction of air at a specific temperature at the inlet port and a specific discharge pressure at the exhaust port, which can be perceived as enhanced performance over Free Air Flow rated blowers. Therefore, we are also providing the following vacuum performance for Gast blowers in CFM Inlet Air for comparison to other blower manufacturer's advertising.

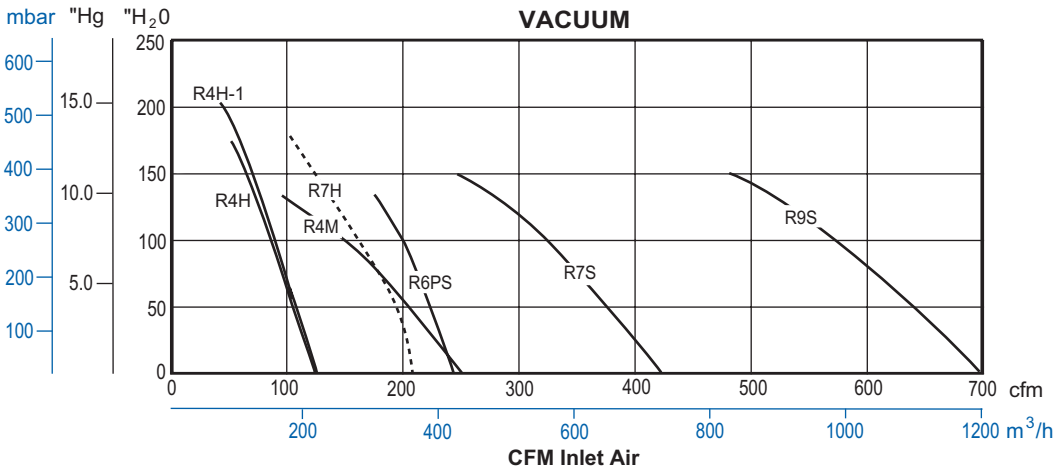



HIGH PRESSURE MODELS



R4M SERIES MODEL R4M3090A

MAX. PRESSURE – 170" H₂O (60 Hz), 150" H₂O (50 Hz)
 MAX. VACUUM – 136" H₂O (60 Hz), 125" H₂O (50 Hz)
 MAX. AIR FLOW – 252 CFM (60 Hz), 217 CFM (50 Hz)

PRODUCT FEATURES

- Rugged construction, low maintenance
- Oilless operation
- UL and CSA approved TEFC motor with permanently sealed ball bearings
- IP54 rated enclosure on motors
- Cast aluminum dual impeller, blower housing and cover
- Can be mounted in any plane
- Inlet and outlet have internal muffling

RECOMMENDED ACCESSORIES

- Pressure gauge AE133A
- Inlet filter AJ126F (pressure)
- Vacuum gauge AE134F or AE134
- Vacuum gauge for monitoring inlet filter restriction AJ497
- Relief valve AG258
- Silencer for vacuum relief valve AJ121D
- Inline filter AJ151G (vacuum)
- External muffler for additional silencing AJ121F

Product Dimensions (in. mm)

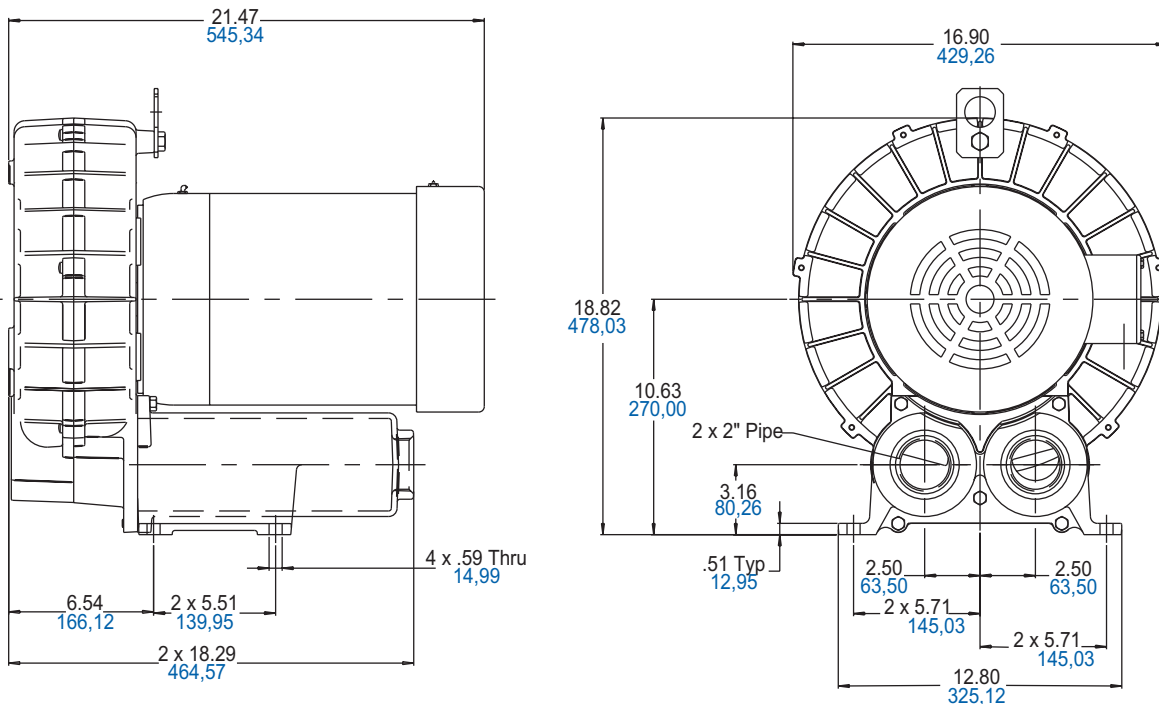



Product Specifications

MODEL NUMBER		R4M3090A
Motor Enclosure		TEFC
HP/kW	60 Hz	9/6,7
	50 Hz	7/5,2
Voltage	60 Hz	208-230/460-3
	50 Hz	190-220/380-440-3
Amps	60 Hz	24-22.2/11.1
	50 Hz	19.8-18.5/9.9-9.3
Starting Amps	60 Hz	105 @ 460V
	50 Hz	79 @ 380V
Insulation Class		F
Recommended NEMA Starter Size		2/1
Net Weight (lbs/kg)		198/90

Reduce maximum duty ratings by 15" H₂O when operating at 207-187 volts (60 Hz)

Product Performance

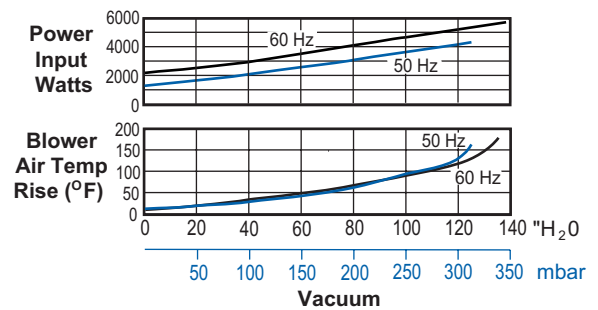
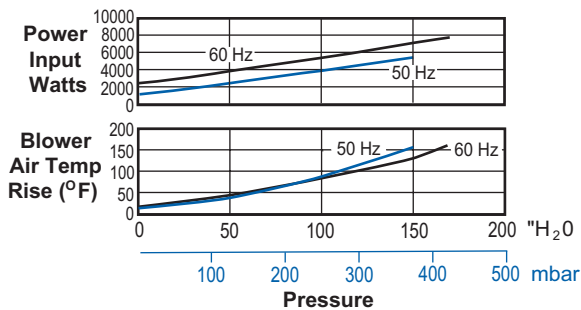
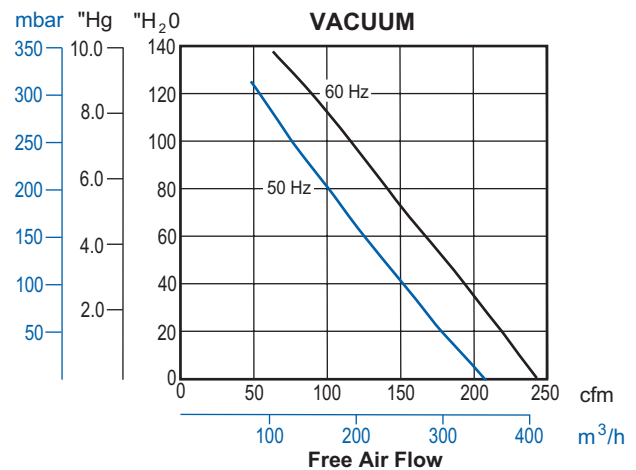
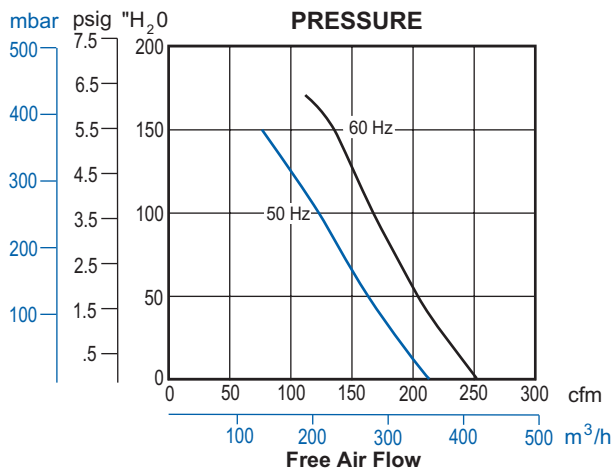



- Q. What happens to the noise when I locate two blowers close together?
- A. If the blowers are of the same design they produce sound frequencies that are close together. These may cause a “beating” change in volume of the blower noise. This is because the units are not synchronized. If two small blowers are needed this change in volume can be reduced by moving them further apart. With larger blowers a dual blower with two blowers on one motor will solve this problem.
- Q. What causes the noise relief valves make?
- A. Air rush through the valve.
- Q. How do I control relief valve or bleed off valve noise?
- A. Attach AJ121 series silencer on the port of the relief valve that is open to atmosphere.
- Contact Gast at 616-926-6171 or www.gastmfg.com with any further questions you may have on reducing blower noise in your application.

Noise Reduction and Absorption Coefficients for Common and Specialty Noise Reduction Materials

	125Hz	250Hz	500Hz	1000Hz	2000Hz	4000Hz	NRC
Brick, unglazed	.03	.03	.03	.04	.05	.07	.04
Carpet							
1/4 in pile height	.05	.10	.15	.30	.50	.55	.26
Fabric							
Heavy Velour							
18 oz per sq. yd							
draped to 1/2 area	.14	.35	.55	.72	.70	.65	.62
Hardwood							
Plywood Paneling							
1/4 in thick							
wood frame	.58	.22	.07	.04	.03	.07	.09
Tecnifoam*							
TFP4							
Pyramid shape	.39	.60	1.21	1.14	1.16	1.13	1.05
Tecnifoam*							
TFW4000							
Anaechoic							
Wedge shape	.64	1.10	1.34	1.23	1.24	1.21	1.25

Source: Mechanical Engineering Reference Manual

*TFP4 and TFW4000 are products of Tecnifoam, Inc., 7145 Boone Avenue North, Minneapolis, MN., 55428

Blower Sound Levels of Gast Blowers

Data is highest sound level out of 4 places around the blower at 1 meter.

Data represents average of several units run at nominal voltage.

Lowest to highest maximum dba level throughout performance range is shown.

Readings at other than the maximum around the blower at 1 meter may be from 2 to 10 dba less than data shown.

Readings taken in a laboratory sound room that does not reflect much noise.

Note: For comparison purposes, some blower manufacturers show sound data from 1–1/2 meters instead of from 1 meter; also, some blower manufacturers show an “average” sound level across performance instead of the full range between minimum and maximum sound levels; either of these methods will provide different and usually lower sound levels compared to Gast’s sound level method.

60Hz	dBa at Pressure	50Hz	dBa at Pressure
R1	59-67	R1	59-64
R2	66	R2	61-63
R3	67-70	R3	63-68
R4	69-73	R4	64-69
R4P	69-75	R4P	64-71
R5	73-77	R5	71-77
R6	73-79	R6	70-79
R6P	82-83	R6P	77-80
R6PP	77-79	R6PP	73-76
R6PS	76-77	R6PS	72-75
R7	82-84	R7	77-79
R7P	77-80	R7P	74-79
R7S	75-77	R7S	72-76
R9	82-85	R9	78-85
R9P	81-88	R9P	79-86
R9S	79-81	R9S	77-81
R4H	80-82	R4H	75-81
R4M	82-83	R4M	78-79
R7H	83	R7H	79-81

60Hz	dBa at Vacuum	50Hz	dBa at Vacuum
R1	58-63	R1	54-60
R2	67	R2	63-64
R3	67-71	R3	64-69
R4	70-72	R4	66-70
R4P	73-74	R4P	68-71
R5	75-76	R5	71-73
R6	78-80	R6	74-77
R6P	81-85	R6P	79-81
R6PP	81-83	R6PP	78-79
R6PS	79-81	R6PS	76-77
R7	85-87	R7	79-84
R7P	84-86	R7P	80-83
R7S	82-83	R7S	78-80
R9	85-90	R9	83-84
R9P	88-90	R9P	84-87
R9S	87-88	R9S	83-86
R4H	82-89	R4H	79-88
R4M	85-89	R4M	80-85
R7H	82-91	R7H	80-90